

SHARP

No.	LCY-02097A
DATE	Jun. 19 . 2003

TECHNICAL LITERATURE
FOR
TFT - LCD module

MODEL No. LQ070T5CRQ2

The technical literature is subject to change without notice.
So, please contact Sharp or its representative before designing
your product based on this literature.

SHARP CORPORATION
ENGINEERING DEPARTMENT II
MOBILE LCD DESIGN CENTER
MOBILE LIQUID CRYSTAL DISPLAY GROUP

C O N T E N T S

	Page
(1) Introduction	2
(2) Features	2
(3) Construction and Outline	2
(4) Module geometry	2
(5) Input/Output terminal	3
(6) Absolute maximum ratings	7
(7) Electrical characteristics	8
(8) Optical characteristics	10
(9) Mechanical characteristics	12
(10) Display quality	12
(11) Handling instructions	12
 Attached Figures	
Fig.1 Outline dimensions of TFT-LCD module	15
Fig.2 Display mode	6
Fig.3 Input signal waveforms	16
Fig.4 Recommended circuit of TFT-LCD module.....	17

(1) Introduction

The SHARP Color TFT-LCD module is an active matrix LCD (Liquid Crystal Display) produced by making the most of Sharp's expertise in liquid-crystal and semiconductor technologies.

The active device is amorphous silicon TFT (Thin Film Transistor). The module accepts full color video signal conforming to the NTSC(M) and PAL(B·G) system standards.

Module geometry(Mechanical specification): Table 1

(2) Features

- Utilizes a panel with a 16:9 aspect ratio, which makes the module suitable for use in wide screen systems.
- By adopting an active matrix drive, a picture with high contrast is realized.
- Through the use of TN-normally white mode, an image with highly natural color reproduction is realized.
- The 7.0" screen produces a high resolution image that is composed of 112,320 pixel elements in a stripe arrangement.
- Built-in video interface circuit (including chroma demodulator, picture tone) and control circuit responsive to NTSC/PAL composite video signal and NTSC/PAL analog RGB signal.
- The inverter circuit having -within for the backlight lighting -up(dimming is available)
- An anti-glare and low-reflection (AG LR with wide viewing angle) surface polarization plate is used.
- Viewing angle: 12 o'clock
- An inverted video display in the vertical and horizontal directions is possible.

(3) Construction and Outline

- Outline dimensions of TFT-LCD module : See Fig. 1
- The module consists of a TFT-LCD panel, drivers, control PWB mounted with electronic circuits, backlight, frame, front and rear shielding cases.

(4) Module geometry(Mechanical specification)

Table 1

Parameter	Specification	Unit	Remarks
Display format	112,320	Pixels	
	1440(H) × 234(V)	dots	
Active area	154.1 (H) × 87.0 (V)	mm	
Screen size (Diagonal)	17.7 [7.0"]	cm	
Dot pitch	0.107(H) × 0.372(V)	mm	
Dot configuration	R·G·B Stripe configuration		
Outline dimension	(192.4)(W) × (109.5)(H) × (19.4)(D)	mm	【Note 4-1】
Mass	370(Max)	g	

【Note 4-1】 This measurement is typical, and see Fig.1 for the details .

(5)Input / Output terminal
5-1)TFT-LCD panel driving section

Table 2

CN1

Pin No.	Symbol	i/o	Description	Remarks
1	VBS	i	Composite video signal	【Note5-1】
2	GND1	i	signal GND	
3	GND1	i	signal GND	
4	NTP	i	Selection for NTSC or PAL	【Note5-1】
5	VCC	i	power supply voltage (8~18V)	
6	THM	o	Thermistor sensor output	
7	INV	i	Turning the direction of vertical and horizontal scanning	【Note5-2】
8	MODS	i	Selection for display mode	【Note5-3】
9	MODW	i	Selection for display mode	【Note5-3】
10	MODN	i	Selection for display mode	【Note5-3】
11	PWMI	i	Input signal for backlight dimming	
12	VBL	i	power supply voltage for Back light	
13	VBL	i	power supply voltage for Back light	
14	GND2	i	Back light GND	
15	GND2	i	Back light GND	

CN2

Pin No.	Symbol	i/o	Description	Remarks
1	VR	i	video signal(Red)	
2	VG	i	video signal(Green)	
3	VB	i	video signal(Blue)	
4	GND1	i	signal GND	
5	SYNC	i	Composite Sync for RGB Video	【Note5-1,4】
6	BRT	i	Brightness adjusting terminal	【Note5-5】
7	COLOR	i	Color adjusting terminal	【Note5-5】
8	TINT	i	Tint adjusting terminal	【Note5-5】
9	VSW	i	Selection video signal of Composite or RGB	【Note5-6】
10	HSY	i/o	Input/output horizontal sync. signal(low active)	【Note5-7】
11	VSY	i/o	Input/output vertical sync. signal(low active)	【Note5-8】
12	CLKC	i	Change the input/output direction of CLK,HSY,VSY	【Note5-9】
13	CLK	i/o	Input/output clock signal	【Note5-10】
14	GND1	i	signal GND	

'High' and 'Low' refer to table 5 [digital input voltage].

【Note5-1】 NTP="Hi" : NTSC system

NTP="Lo" : PAL system

When selected NTSC or PAL, supplied power for the module is OFF.

【Note5-2】 INV="Hi" : Regular video

INV="Lo" : Vertically and horizontal inverted video

【Note5-3】 Display mode settings are given in Table 3.

【Note5-4】 This terminal should be input composite sync. signal without Chroma/burst signal.

【Note5-5】 Adjusted by the DC voltage supplied to this terminal.

They are adjusted to the optimum value on shipping, but, they can be re-adjusted by external circuit.

TINT: adjustable(NTP="Hi" :NTSC),not adjustable(NTP="Lo":PAL).

When "NTP" terminal is "Lo",this terminal should be "OPEN".

【Note5-6】 Selects input signals, composite or analog RGB.

When VSW is "Lo", composite video signal is selected.(input terminal is CN1- No.1:VBS)

When VSW is "Hi", analog RGB signal is selected.(input terminal is CN2 -No.5:SYNC and CN2-No.1 to No.3:VR,VG,VB)

【Note5-7】 When CLKC="Hi", the output is a horizontal synchronizing signal synchronized by the SYN signal. When CLKC="Lo", the module is synchronized via the horizontal synchronizing signal input at this terminal.

【Note5-8】 When CLKC="Hi", the output is a vertical synchronizing signal synchronized by the SYN signal. When CLKC="Lo", the module is synchronized via the vertical synchronizing signal input at this terminal.

【Note5-9】 CLKC="Hi" : CLK,HSY and VSY terminals are in the output mode.

CLKC="Lo" : CLK,HSY and VSY terminals are in the input mode.

【Note5-10】 When CLKC="Hi", the output level is low.

When CLKC="Lo", module operation is based on the input clock signal. This signal should correspond to sampling timing of the horizontal direction image. NTP,MODS,MODW and MODN should be "Hi" then CLKC="Lo".

Table 3 Display Method and Characteristics

MODS	MODW	MODN	Display mode	Characteristics	Source	example
H	H	H	Full mode	The picture is displayed with uniform enlargement in the horizontal direction, and the horizontal retrace line of the input signal cannot be seen. If the video sampling frequency of the image is fixed and a 4:3 video signal is displayed, the picture will be prominently oblong.	4:3 signal, avigation signal	Fig.2-1
H	H	L	Wide mode 1	A 4:3 video signal is displayed with less feeling of incongruity than that in the full screen mode. Since the video horizontal sampling frequency is modulated in the horizontal direction, the degree of perfect roundness in the center of the screen is improved over that of the full screen mode.	4:3 signal	Fig.2-2
H	L	H	Normal mode	When displaying a 4:3 video signal, the displayed image is slightly less than perfectly round and the horizontal retrace line period is displayed at the two edges of the screen. With respect to the video horizontal sampling frequency, the center portion of the screen is slightly lower and the two edges become slightly higher. With respect to the horizontal retrace line period, a far better display is achieved than that of masking of the video signal by the VCS signal timing.	4:3 signal	Fig.2-3
H	L	L	Cinema mode	A letter-box type image (16:9 signal) is displayed over the central width of the screen. In the horizontal direction, full screen display is utilized. Due to the display being extended in the vertical direction, a slightly less than perfectly round image is displayed.	letter box type wide signal(16:9signal)	Fig.2-4
L	H	H	Wide mode 2	In the horizontal direction, the Wide 1 display mode is employed. Due to the display being extended in the vertical direction, the portion of the picture in the center of the screen is slightly less than perfectly round. Also due to extending in the vertical direction, the upper and lower portions of the image are not displayed.	4:3 signal	Fig.2-5
L	H	L	test	This mode is unusable as it is the test mode.	—	—
L	L	H	test	This mode is unusable as it is the test mode.	—	—
L	L	L	test	This mode is unusable as it is the test mode.	—	—

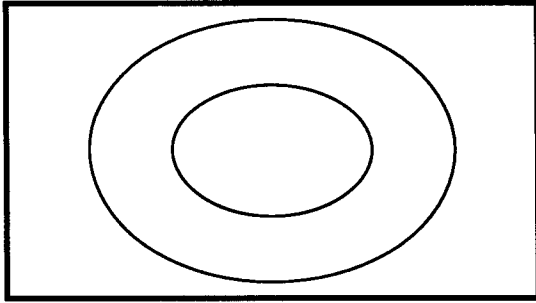

Fig.2-1 Full mode

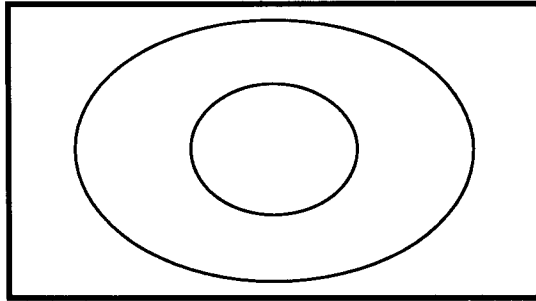

Fig.2-2 Wide 1 mode

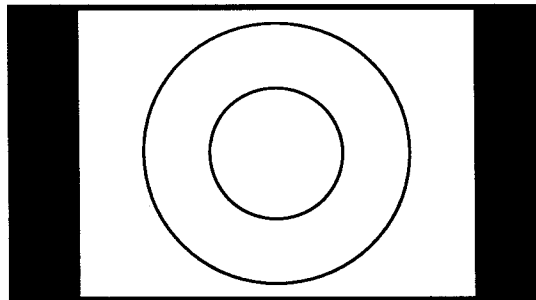

Fig.2-3 Normal mode

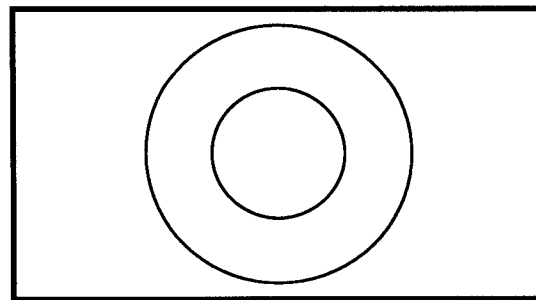

Fig.2-4 Cinema mode

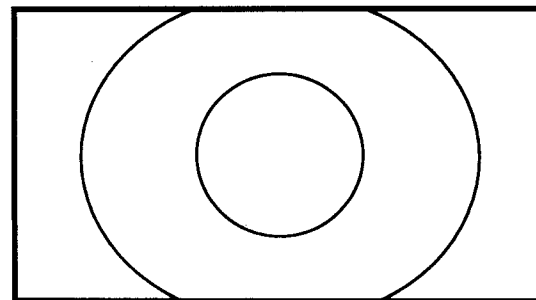

Fig.2-5 Wide 2 mode

(6) Absolute maximum ratings

Table 4

GND=0V、T_a=25°C±5°C

Parameter	Symbol	MIN	MAX	Unit	Remarks	
Positive power supply voltage	V _{IN}	-1.0	+24.0	V	【Note 6-1】	
Analog input signals	V _i	-	2.0	V _{p-p}	【Note 6-2】	
Digital input signals	V _I	-0.2	+5.4	V	【Note 6-3】	
Adjusting terminal voltage	V _{adj}	-0.2	+5.4	V	【Note 6-4】	
Storage temperature	T _{stg}	-40	+85	°C	【Note 6-5】	
Operating Temperature	Surface of panel	Top1	-30	+85	°C	【Note 6-5, 6, 7】
	Environment	Top2	-30	+70	°C	【Note 6-7, 8】

【Note 6-1】 +24V time duration is two(2) minutes.

【Note 6-2】 VBS, VR, VG, VB terminals (Video signal)

【Note 6-3】 NTP, HRV, VRV, MODS, MODW, MODN, CLKC, VSW terminals

【Note 6-4】 BRT, COLOR, TINT terminals

【Note 6-5】 The temperature of panel surface must not exceed this rating.

【Note 6-6】 Maximum wet-bulb temperature must be less than 58°C. No dew condensation.

【Note 6-7】 The operating temperature assure only driving. Contrast, response time, the other display quality is judgment at 25°C.

【Note 6-8】 The temperature around considering that the backlight lighting-up generates heat. (The reference value)

(7)Electrical characteristics
7-1)Recommended operating conditions

Table 5

GND=0V, Ta=25°C±5°C

Parameter	Symbol	MIN.	TYP.	MAX.	Unit	Remarks		
Power supply voltage	VIN	+8.0	+13.8	+18.0	V			
Power supply voltage rising time	τ VIN			(80)	ms	[Note7-1]		
Analog input voltage	VIDEO	V1	-	0.714	-	Vp-p	[Note7-2]	
			-	0.700	-	Vp-p	[Note7-4]	
	SYNC.	V2	0.272	0.286	0.300	Vp-p	[Note7-2]	
			-	1.0	-	Vp-p	[Note7-3]	
	Chroma/burst	V3	0.272	0.286	0.300	Vp-p	[Note7-2]	
DC component	Vidc	-0.1	0	+1.0	V	[Note7-5]		
Digital input voltage	Hi	Vih	+4.0	-	+5.2	V	[Note7-6]	
	Lo	Vil	0	-	+1.0	V		
Input horizontal sync. component	frequency	NTSC	fH(N)	15.00	15.73	16.50	kHz	CLKC="Hi" [Note7-7]
		PAL	fH(P)	15.20	15.62	16.00	kHz	
	pulse width	NTSC	τ HI(N)	4.2	4.7	5.2	μ s	
		PAL	τ HI(P)	4.2	4.7	5.2	μ s	
	rising time	τ rHI1	-	-	0.5	μ s		
falling time	τ fHI1	-	-	0.5	μ s			
Input vertical sync. component	frequency	NTSC	fV(N)	fH/284	fH/262	fH/258	Hz	CLKC="Hi" [Note7-8]
		PAL	fV(P)	fH/344	fH/312	fH/304	Hz	
	pulse width	NTSC	τ VI(N)	-	3H	-	μ s	
		PAL	τ VI(P)	-	2.5H	-	μ s	
	rising time	τ rVI	-	-	0.5	μ s		
falling time	τ fVI	-	-	0.5	μ s			
Input clock	frequency	fCLI	-	9.5	-	MHz	CLKC="Lo"	
	Hi pulse width	τ WH	20.0	-	-	ns		
	Lo pulse width	τ WL	20.0	-	-	ns		
	rising time	τ rCLI	-	-	10.0	ns		
	falling time	τ fCLI	-	-	10.0	ns		
Input horizontal sync. signal	frequency	fHI	fCLI/620	fCLI/608	fCLI/590	kHz	CLKC="Lo"	
	pulse width	τ HI	1	5	9	μ s		
	rising time	τ rHI2	-	-	0.05	μ s		
	falling time	τ fHI2	-	-	0.05	μ s		
Input vertical sync. signal	frequency	fVI	50	fHI/262	fHI/258	Hz	CLKC="Lo"	
	pulse width	τ VI	1H	3H	5H	μ s		
Data setup time	tSU1	25	-	-	ns			
Data hold time	tHO1	25	-	-	ns			
Data setup time	tSU2	1.0	-	-	μ s			
Data hold time	tHO2	1.0	-	-	μ s			
video adjustment	brightness	Vbrt	(0)	(+2.7)	(+5.0)	V		
	tint	Vtnt	(0)	(+2.8)	(+5.0)	V		
	color	Vcol	(0)	(+1.9)	(+5.0)	V		
B/L dimmer adjust	voltage	VPWM	0	-	5.0	V	PWMI terminal	
	frequency	fPWM	145	150	155	Hz		

Caution: Signals must input after power has been turned on.

【Note 7-1】

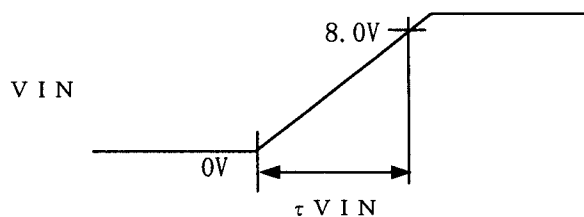

【Note7-2】 VBS terminal (composite video signal)

Input impedance : 75 Ω

【Note7-3】 SYNC terminals (Analog RGB)

【Note7-4】 VR, VG, VB terminals (Analog RGB)

【Note7-5】 VBS, VR, VG, VB terminals

【Note7-6】 HSY, VSY, NTP, HRV, VRV, MODS, MODW, MODN, CLKC, CLK, VSW terminals

Input impedance : >10kΩ

【Note7-7】 VBS (horizontal sync. component)

【Note7-8】 VBS (vertical sync. component)

7-2) Power consumption

Table 6

Ta=25°C±5°C

Parameter	Symbol	Voltage	MIN.	TYP.	MAX.	Unit	Remarks
Supply current	I _{cc}	V _{IN} =+13.8V	—	160	200	mA	
Lamp power consumption	I _L	V _{IN} =+13.8V	—	670	750	mA	Dimmer=100%

7-3) Display time range

Displaying the following range within video signals.

(1) NTSC(M) mode (NTP='Hi', CLKC='Hi')

(a1) Horizontally : 13.0 ~ 63.3 μs from the falling edge of HSY. (full, wide1, 2, cinema)

(a2) Horizontally : 7.6 ~ 68.8 μs from the falling edge of HSY. (normal)

(b1) Vertically : 20 ~ 253 H from the falling edge of VSY. (full, wide1, normal)

(b2) Vertically : 49 ~ 224 H from the falling edge of VSY. (cinema)

(b3) Vertically : 42 ~ 228 H from the falling edge of VSY. (wide2)

(2) PAL(B·G) mode (NTP='Lo', CLKC='Hi')

Displaying the following range within video signals.

(a1) Horizontally : 13.0 ~ 63.3 μs from the falling edge of HSY. (full, wide1, 2, cinema)

(a2) Horizontally : 7.6 ~ 68.8 μs from the falling edge of HSY. (normal)

(b1) Vertically : 26~298 H from the falling edge of VSY. (full, wide1, normal)

However, the video signals of (14n+12)H, (14n+20)H/Even field.

(14n+17)H, (14n+23)H/Odd field (n=1, 2, ..., 20)

are not displayed on the module.

(b2) Vertically : 40~284 H from the falling edge of VSY. (cinema)

However, the video signals of (42n)H, (42n+22)H/Even field.

(42n+13)H, (42n+35)H/Odd field (n=1, 2, ..., 20)

are not displayed on the module.

(b3) Vertically : 35~289 H from the falling edge of VSY. (wide2)

However, the video signals of (22n+14)H, (22n+24)H/Even field.

(22n+21)H, (22n+31)H/Odd field (n=1, 2, ..., 20)

are not displayed on the module.

(3) External clock mode (NTP='Hi', CLKC='Lo')

Displaying the following range within video signals.

(a) Horizontally : 103 ~ 582 clk from the falling edge of HSY.

(clk means input external clock.)

(b) Vertically : 20 ~ 253 H from the falling edge of VSY.

(8)Optical characteristics

Table 7

Ta=25°C±5°C

Parameter	Symbol	Condition	Min	Typ	Max	Unit	Remarks	
Viewing angle range	$\Delta \theta 11$	CR \geq 10	(30)	(40)	-	° (degree)	【Note 8-1, 2, 3】	
	$\Delta \theta 12$		(50)	(60)	-	° (degree)		
	$\Delta \theta 2$		(50)	(60)	-	° (degree)		
Contrast ratio	CRmax	Optimal	(100)	(300)	-		【Note 8-2, 3】	
Response time	Rise	$\theta = 0^\circ$	-	(11)	(40)	ms	【Note 8-2, 4】	
	Fall		-	(22)	(72)	ms		
Luminance	Y		(450)	(500)	-	cd/m ²	【Note 8-5】	
White chromaticity	x	Dimmer=100%	0.263	0.313	0.363		【Note 8-5】	
	y		0.279	0.329	0.379			
Lamp life time	+25°C	-	continuation	10,000	-	-	hour	【Note 8-6】
	-30°C	-	intermission	2,000	-	-	time	【Note 8-7】

【Note 8-1】 Viewing angle range is defined as follows.

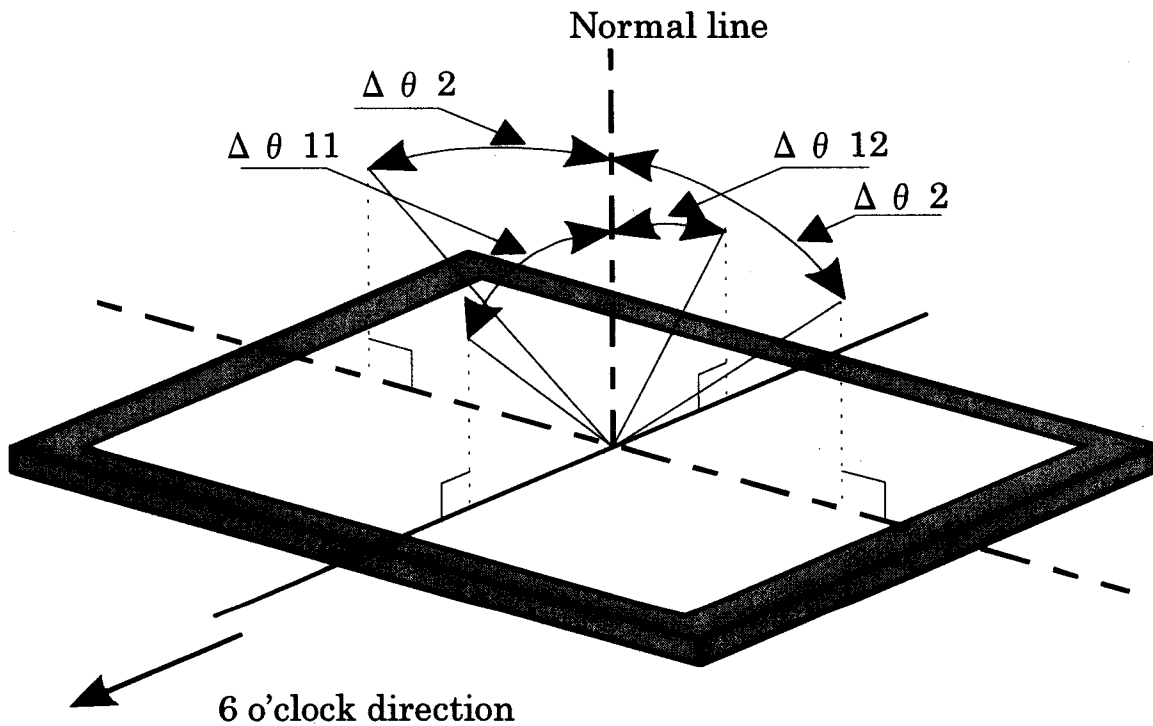

Fig. (i) definition for viewing angle

【Note 8-2】 Applied voltage condition:

- (1) VCDC is adjusted so as to attain maximum contrast ratio.
- (2) Adjusting voltage (BRT, CONT, COLOR, TINT) is open.
- (3) Input video signal of standard black level and 100% white level.

【Note 8-3】 Contrast ratio is defined as follows:

$$\text{Contrast ratio(CR)} = \frac{\text{Photo detector output with LCD being "white"}}{\text{Photo detector output with LCD being "black"}}$$

【Note 8-4】 Response time is obtained by measuring the transition time of photo detector output, when input signals are applied so as to make the area "black" to and from "white".

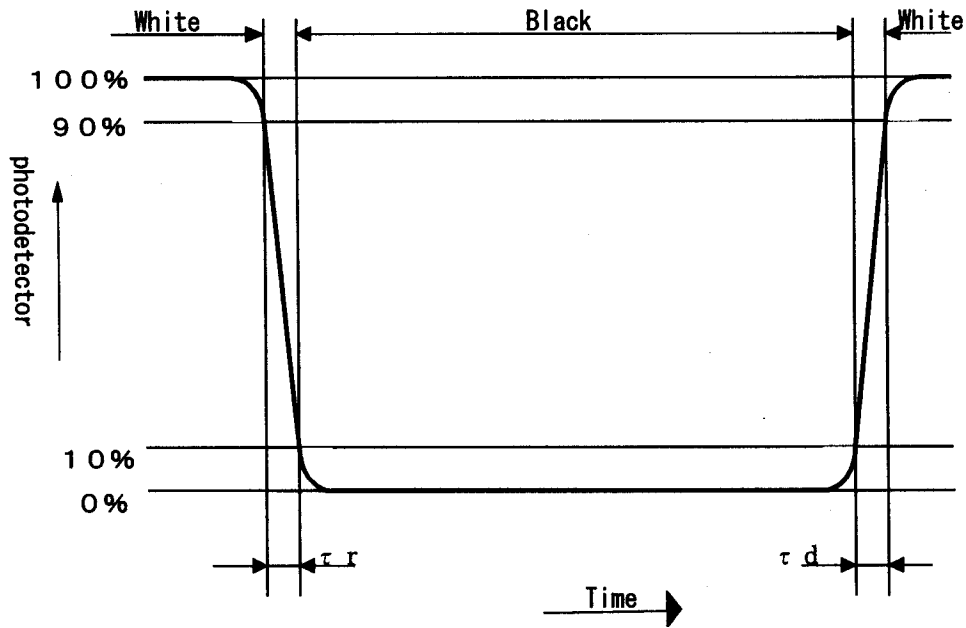

Fig. (ii)

【Note 8-5】 Measured on the center area of the panel at a viewing cone 1° by TOPCON luminance meter BM-7. (After 30 minutes operation)

【Note 8-6】 Lamp life time is defined as the time when the brightness of the panel not to become less than 50% of the original value.

(operation conditions)

Current dimming: PWM dimming 100%~5%

【Note 8-7】 The intermittent cycles is defined as a time when brightness not to become under 50% of the original value under the condition of following cycle. (See Fig. (iii).)

(condition)

Ambient temperature: -30°C

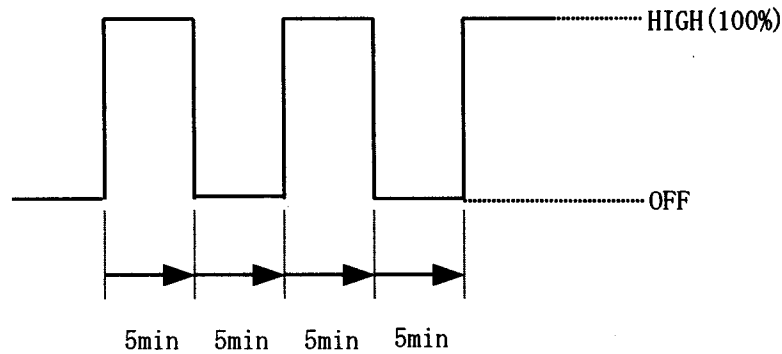

Fig. (iii)

(9)Mechanical characteristics

9-1) External appearance

Do not exist extreme defects. (See Fig. 1)

9-2) Panel toughness

The panel shall not be broken, when 19N is pressed on the center of the panel by a smooth sphere having 15 mm diameter.

Caution: In spite of very soft toughness, if, in the long-term, add pressure on the active area, it is possible to occur the functional damage.

9-3) Input/output connector performance

A) Input/output connectors for the operation of LCD module (15 pin and 14 pin)

Table 8. I/O connector of module driving

Symbol	Used Connector	Manufacture
CN1	53261-15	Molex
CN2	53261-14	Molex

(10) Display quality

The display quality of the color TFT-LCD module shall be in compliance with the incoming Inspection Standard.

(11) Handling instructions

11-1) Mounting of module

The TFT-LCD module is designed to be mounted on equipment using the mounting tabs in the four corners of the module at the rear side.

On mounting the module, as the M2.5 tapping screw (fastening torque is 0.35 through 0.45N·m) is recommended, be sure to fix the module on the same plane, taking care not to wrap or twist the module.

To pushing module, (ex. touching switch etc.) causes disordered image.

So taking care not to conduct directly for LCD module.

Please power off the module when you connect the input/output connector.

11-2) Precautions in mounting

- ① Polarizer which is made of soft material and susceptible to flaw must be handled carefully.

Protective film (Laminator) is applied on the surface to protect it against scratches and dirt.

It is recommended to peel off the laminator immediately before the use, taking care of static electricity.

- ② Precautions in peeling off the laminator

A) Working environment

When the laminator is peeled off, static electricity may cause dust to stick to the polarizer surface. To avoid this, the following working environment is desirable.

- a) Floor: Conductive treatment of 1MΩ or more on the tile
(conductive mat or conductive paint on the tile)
- b) Clean room free from dust and with an adhesive mat on the doorway
- c) Advisable humidity:50%~70% Advisable temperature:15℃~27℃
- d) Workers shall wear conductive shoes, conductive work clothes, conductive gloves and an earth band.

B) Working procedures

- a) Direct the wind of discharging blower somewhat downward to ensure that module is blown sufficiently. Keep the distance between module and discharging blower within 20 cm. (See Fig. (iv).)
- b) Attach adhesive tape to the laminator part near discharging blower so as to protect polarizer against flaw. (See Fig. (iv).)
- c) Peel off laminator, pulling adhesive tape slowly to your side taking 5 or more second.
- d) On peeling off the laminator, pass the module to the next work process to prevent the module to get dust.
- e) Method of removing dust from polarizer
 - Blow off dust with N2 blower for which static electricity preventive measure has been taken.
 - Since polarizer is vulnerable, wiping should be avoided.

But when the panel has stain or grease, we recommend to use adhesive tape to softly remove them from the panel.

③When metal part of the TFT-LCD module (shielding lid and rear case) is soiled, wipe it with soft dry cloth. For stubborn dirties, wipe the part, breathing on it.

④Wipe off water drop or finger grease immediately. Long contact with water may cause discoloration or spots.

⑤TFT-LCD module uses glass which breaks or cracks easily if dropped or bumped on hard surface. Handle with care.

⑥Since CMOS LSI is used in this module, take care of static electricity and earth your body when handling.

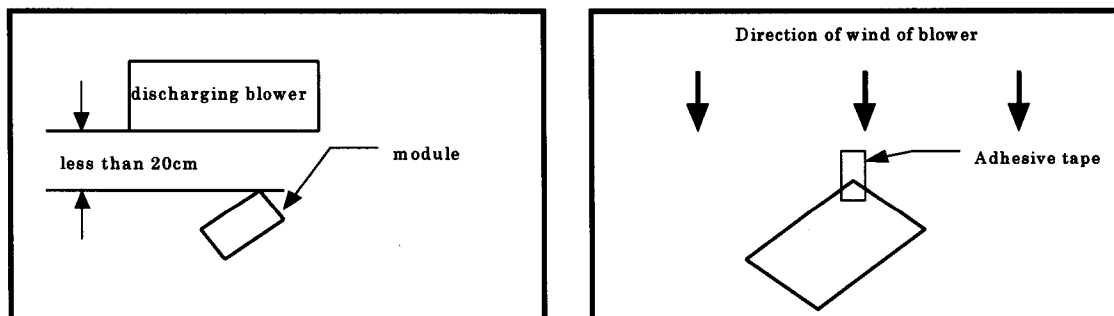

Fig . (iv)

11-3) Precautions in adjusting module

Adjusting volumes on the rear face of the module have been set optimally before shipment. Therefore, do not change any adjusted values.

If adjusted values are changed, the specifications described here may not be satisfied.

11-4) Caution of product design

The LCD module shall be protected against water salt-water by the waterproof cover.

Please take measures to interferential radiation from module,
not to interfere surrounding appliances.

11-5) Others

- ①Do not expose the module to direct sunlight or intensive ultraviolet rays for many hours;
liquid crystal is deteriorated by ultraviolet rays.
- ②Store the module at a temperature near the room temperature. At lower than the rated
storage temperature, liquid crystal solidifies, causing the panel to be damaged. At higher
than the rated storage temperature, liquid crystal turns into isotropic liquid and may not
recover.
- ③The voltage of beginning electric discharge may over the normal voltage because of leakage
current from approach conductor by to draw lump read lead line around. If LCD panel breaks,
there may be a possibility that the liquid crystal escapes from the panel. Since the
liquid crystal is injurious, do not put it into the eyes or mouth. When liquid crystal
sticks to hands, feet or clothes, wash it out immediately with soap.
- ④Observe all other precautionary requirements in handling general electronic components.

SHARP

Outline Dimension

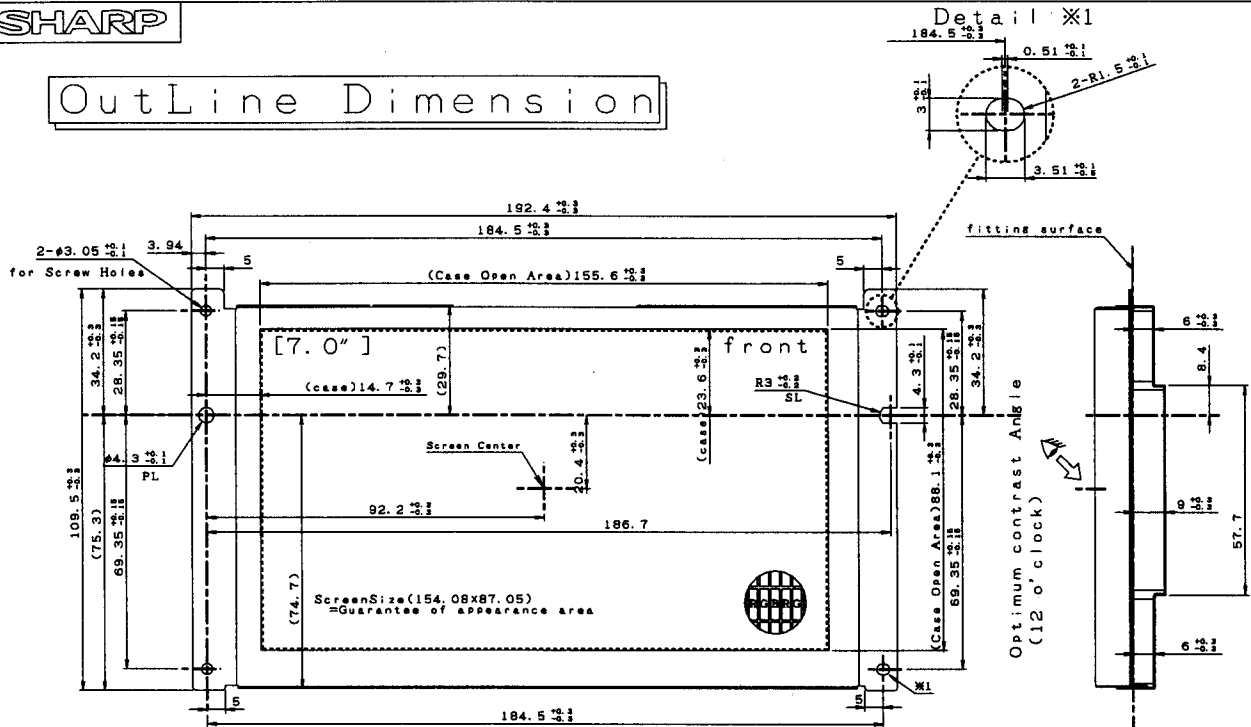

PL: PRIMARY LOCATOR
SL: SECONDARY LOCATOR

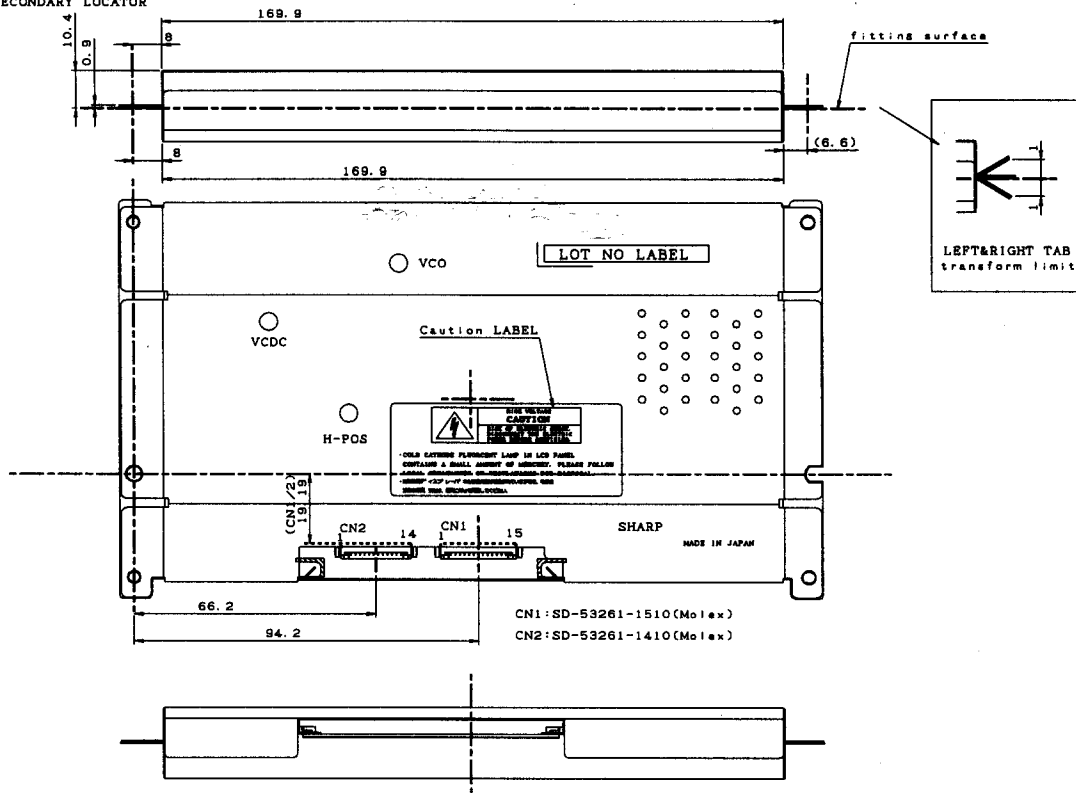

Take care in set design to hide the scratches and bubbles appeared on the polarizer or other frame area which is located outside of active area.

unit:mm

General tolerance is ± 0.3

Please do not copy this material and do not disclose this to third party.

DATE	2003.03.20	SCALE	free		
MODEL	LCY070T5CRQ2				
DRAWING NO	LCM-02078G	size	A4	REVISION	
SHARP CO. LTD			MOBILE LCD DESIGN CENTER ENGINEERING DEPT. 11		

Fig1. Out Line Dimension

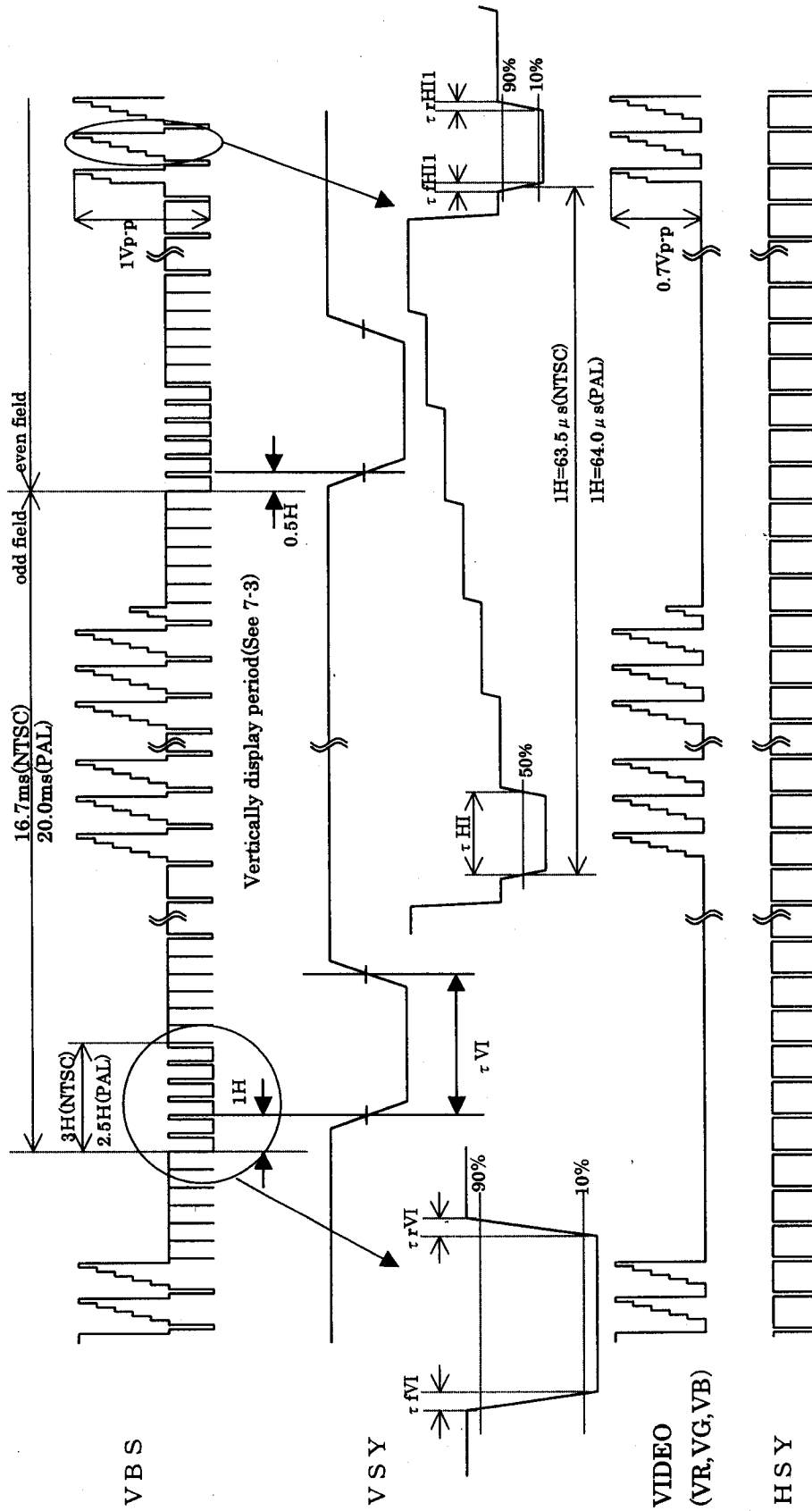

Fig. 3 Input signal waveforms

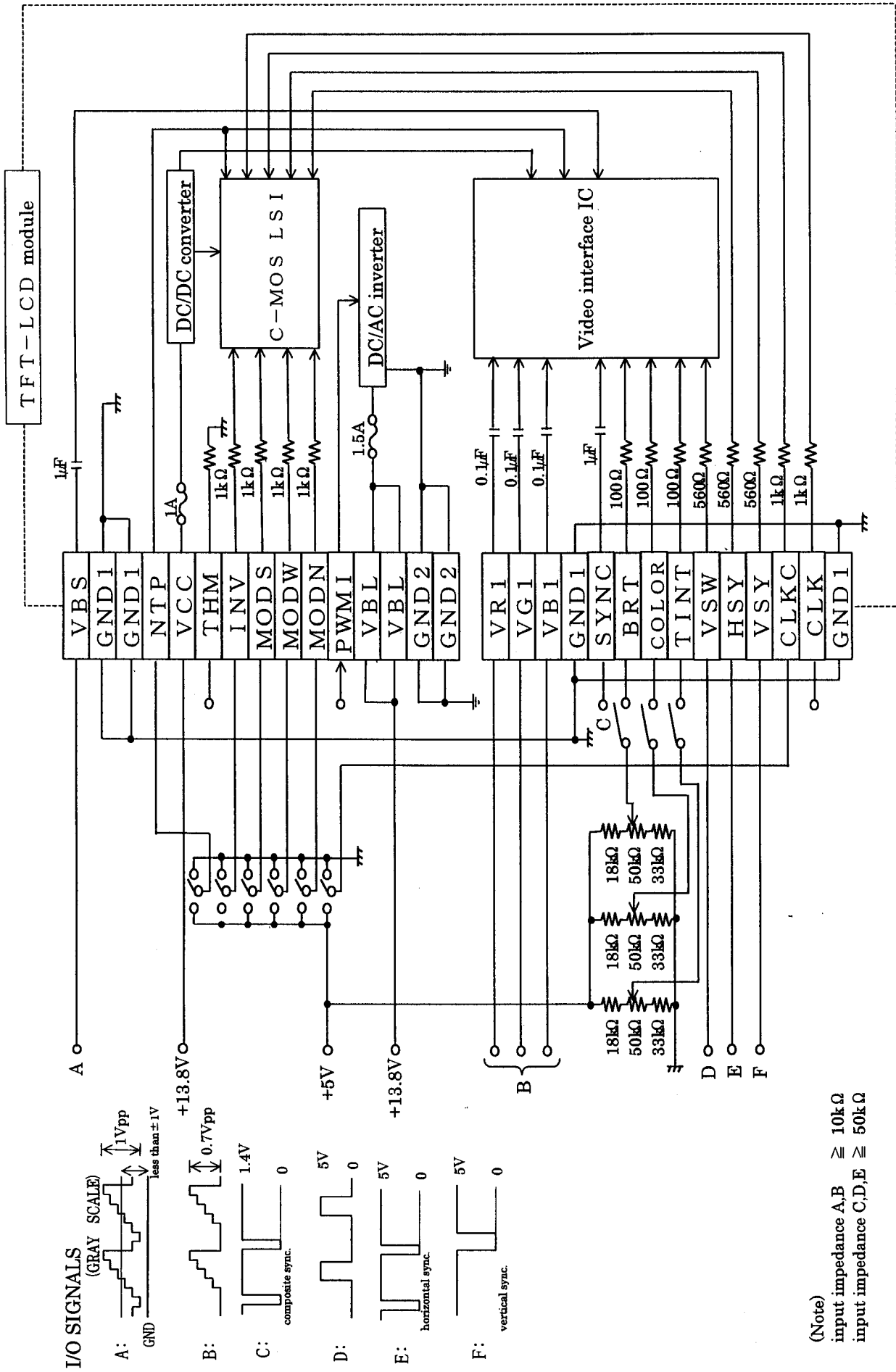

Fig.4 Recommended circuit of TFT-LCD module